

P : 100V

S : 12V 100VA

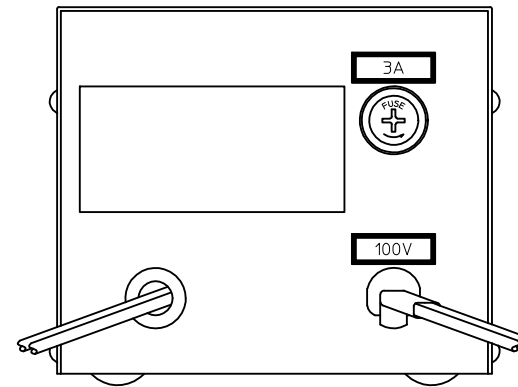
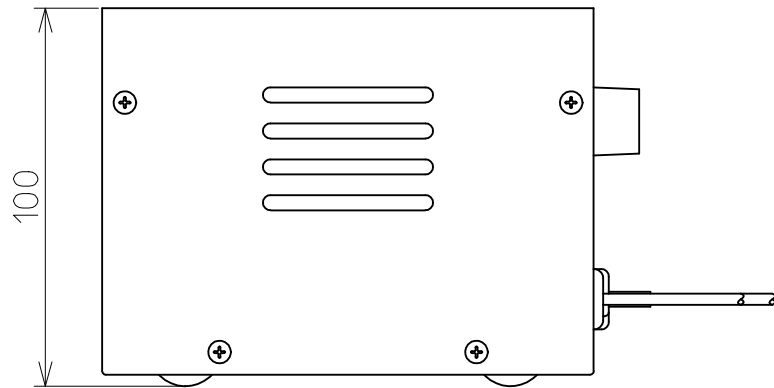

REVISED	FILE NO.	有限会社 タナカパーツ製作所	DATE	SCALE	A P	C H	D R
	PART NO. 100VA		2003.1.6				