

P : 100V
S : 24V 180VA

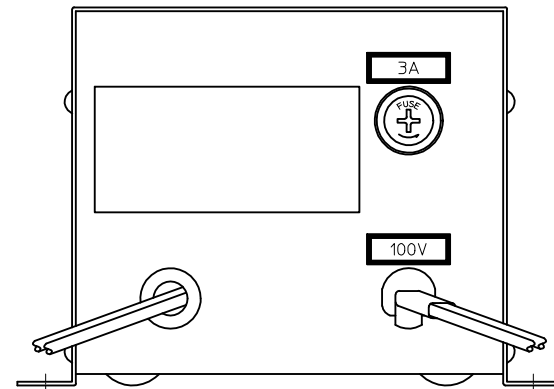
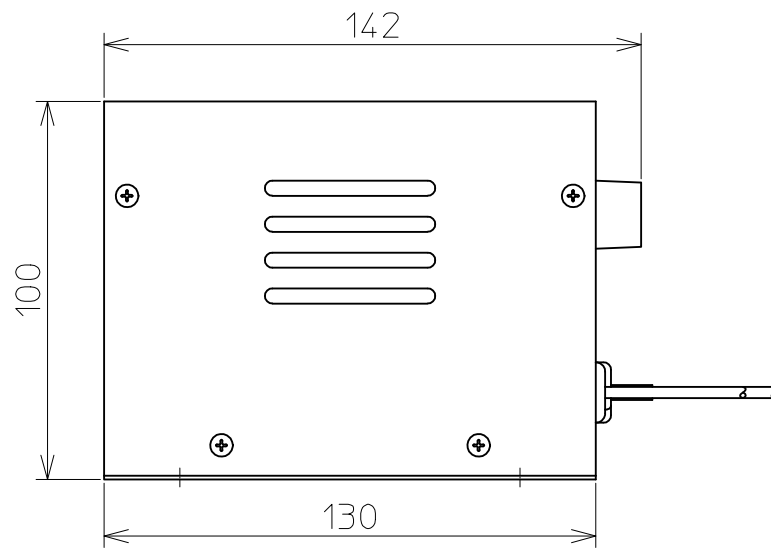

REVISED	FILE NO.	有限会社 タナカパーツ製作所	DATE	SCALE	A P	C H	D R
	PART NO. 180VA		2003.9.29				